

⚠ Caution | Do not mark on the model and other components with pen nor leave printed materials contacted on surface.
Ink marks on the models cannot be removed.

MW17

Ultrasound Guided Thoracentesis / Pericardiocentesis Simulator Full set

Instruction Manual



1. Thoracentesis Training
[Fitted on the Upper Torso Manikin]



1. Thoracentesis Training
[Fitted on a SP]



2. Pericardiocentesis Training

Contents

- Introduction
 - Manufacturer's Note P. 1
 - DOs and DON'Ts P. 1
- Before You Start
 - Set Includes P. 2
- 1. Thoracentesis Training
 - Preparation
 - Assembly of the Thoracentesis Units P.3-P.4
 - Control the Volume of Pleural Effusion..... P.5-P.6
 - Fill the Puncture Unit with Water P. 7
 - Set the Puncture Unit to the Upper Torso Manikin ... P. 8
 - Wear the Puncture Unit on the Chest P.8-P.9
 - Training
 - Patient Positioning..... P. 10
 - Training using the Explanation Model P.11-P.12
 - Change the Effusion Volume P.13-P.14 during the Session
 - After Training P.15-P.17
 - Replacement of the Consumable Parts
 - Simulated Lung/Thoracentesis Pad P.18-P.20
- 2. Pericardiocentesis Training
 - Preparation
 - Confirm the Setting of Simulated Heat and Liver P. 21
 - Fill the Puncture Unit with Water [1] P.22-P.26
 - Fill the Puncture Unit with Water [2] P.27-P.30
 - Training P.31
 - After Training P.32-P.35

Manufacturer's note

Ultrasound Guided Thoracentesis / Pericardiocentesis Simulator fullset can facilitates trainings in Thoracentesis and Pericardiocentesis. The puncture sites are anatomically correct and reproduce realistic needle-tip resistance and sensation. The upper torso manikin can be set in different position to learn patient positioning for both procedures.

● Features

- Excellent ultrasound image
- Feedback on successful/unsuccessful procedure
- Body torso for one-man training

Thoracentesis skills

- Two sites for access: right mid-scapular line and left mid axially line
- Strap-on puncture units to learn patient positioning and communication
- Anatomy includes: ribs, pleura, soft tissue and diaphragm
- Ribs can be palpated
 - mid-axially line unit: 6-9th rib
 - mid-scapular line unit: 8-11th rib
- Volume of pleural effusion can be controlled to set different levels of challenges

Pericardiocentesis skills

- Puncture site can be determined by ultrasound and palpation
- Anatomy includes: ribs, xiphisternum, heart, liver and soft tissue

This Ultrasound Guided Thoracentesis / Pericardiocentesis Simulator fullset has been developed for the training of medical and paramedical professionals only. Any other use, or any use not in accordance with the enclosed instructions, is strongly discouraged. The manufacturer cannot be held responsible for any accident or damage resulting from such use. Please use this model carefully and refrain from subjecting to any unnecessary stress or wear. Should you have any questions on this simulator, please feel free to contact our distributor in your area or KYOTO KAGAKU at any time. (Our contact address is on the back cover of this manual)

⚠ DOs and DON'Ts

DOs

- Handle the manikin and the components with care.
- Storage in a dark, cool space will help prevent the skin colours from fading.
- The manikin skin may be cleaned with a wet cloth, if necessary, using mildly soapy water or diluted detergent.

DON'Ts

- Do not let ink from pens, newspapers, this manual or other sources contact with the manikin, as they cannot be cleaned off the manikin skin.
- Never use organic solvent like paint thinner to clean the skin, as this will damage the simulator.
- Even if color on its surface might be changed across the ages, this does not affect the quality of its performance.

Handling of Thoracentesis / Pericardiocentesis Pad

- Because the puncture site of the Thoracentesis / Pericardiocentesis pad is made of soft and delicate material, wipe with wet wipes if it gets dirty. Do not apply too much pressure with a dry cloth or other material. The pad can also be deformed and/or deteriorated if it is left in direct contact with other resin products for a long time.

Set Includes

Before you start, ensure that you have all components listed below.



a. Upper torso manikin (including the spacer)	1	j. Lung air tube (for thoracentesis)	1
b. Thoracentesis pad (for mid-axially line access)	1	k. Connection tube (for pericardiocentesis water supply)	1
c. Thoracentesis pad (for mid-scapular line access)	1	l. Connection tube (for pericardiocentesis water drain)	1
d. Thoracentesis container (including simulated lung and diaphragm)	2	m. Syringe (for thoracentesis)	1
e. Pericardiocentesis pad	1	n. Syringe (for pericardiocentesis)	1
f. Pericardiocentesis container (including simulated heart and liver)	1	o. Plastic jar (small)	1
g. Explanation model	1	p. Plastic jar (large)	1
h. Fitting strap for thoracentesis unit (One pair includes 2 straps)	2 pair	q. Funnel	1
i. Pillow	1	r. Irrigation bottle	1
		Instruction manual	

Consumable parts

code	name
11383-010	Thoracentesis pad (for mid-axially line access) (a pair)
11383-020	Thoracentesis pad (for mid-scapular line access) (a pair)
11383-030	Replacement simulated lung (a pair)
11394-010	Pericardiocentesis pad (a pair)



11383-010



11383-020

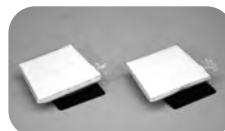

11383-030



11394-010

1. Thoracentesis Training

P.4 ~ P.20



● Components for the thoracentesis training with the upper torso manikin

(Components for MW4)

a. Upper torso manikin (including the spacer)	1	i. Pillow	1
b. Thoracentesis pad (for mid-axially line access)	1	j. Lung air tube	1
c. Thoracentesis pad (for mid-scapular line access)	1	m. Syringe	1
d. Thoracentesis container (including simulated lung and diaphragm)	2	o. Plastic jar (small)	1
g. Explanation model	1	q. Funnel	1
h. Fitting strap for thoracentesis unit (One pair includes 2 straps)	2 pairs		

After training, detach the thoracentesis / pericardiocentesis pad from each container before storing them.

* MW 4 has a spacer instead of the Pericardiocentesis unit



● Components for the thoracentesis training with a SP

(Components for MW4A)

b. Thoracentesis pad (for mid-axially line access)	1	j. Lung air tube	1
c. Thoracentesis pad (for mid-scapular line access)	1	m. Syringe	1
d. Thoracentesis container (including simulated lung and diaphragm)	2	o. Plastic jar (small)	1
h. Fitting strap for thoracentesis unit (One pair includes 2 straps)	2 pairs	q. Funnel	1

1 Assembly of the Thoracentesis Units

The thoracentesis pad and the thoracentesis container are packed separately. Assemble the thoracentesis unit before training.

1. Confirmation of the components

Two types of thoracentesis pad for different puncture sites are included. A sticker is pasted on the top of each pad to indicate the type. Take care to avoid mixing them up. (The shapes of the ribs are different.)

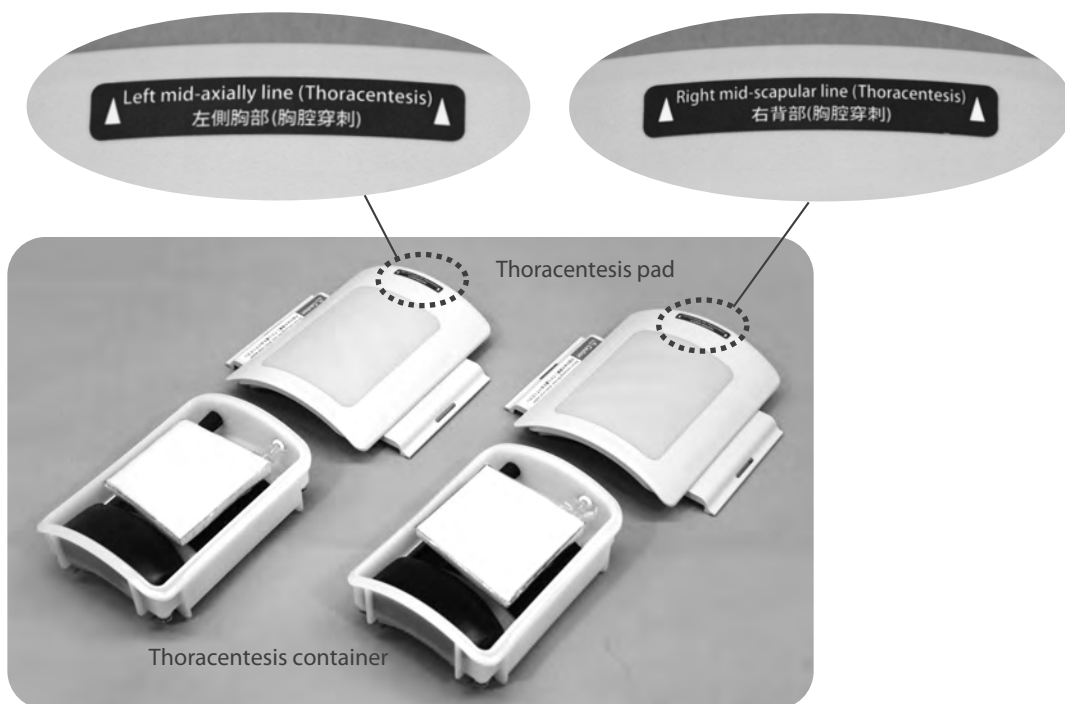

2. Confirm the setting of the simulated lung and diaphragm

The simulated lung and diaphragm are set in the container. Ensure that both parts are in place and fixed securely.

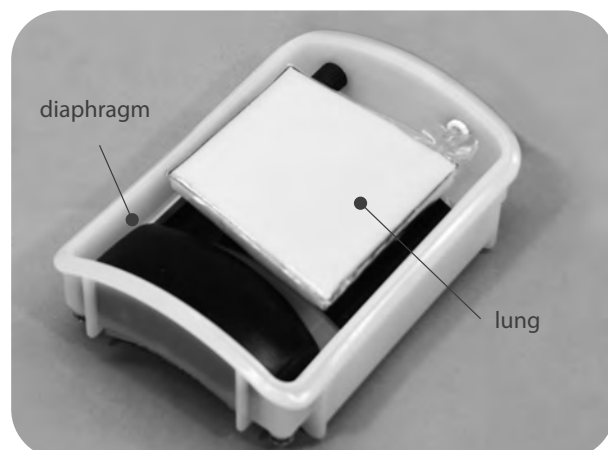

1 Assembly of the Thoracentesis Units

3. Assembling the thoracentesis units

Engage the thoracentesis pad and the thoracentesis container. With the pad (skin) side facing down, push the lock inward with both hands until you hear a "click" sound to engage it securely. After engaging the locks of both sides thread the Velcro tape through the slits on the locks of both sides to hold the pad and the container together.

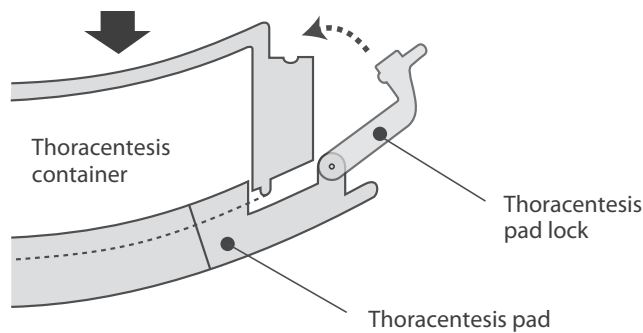
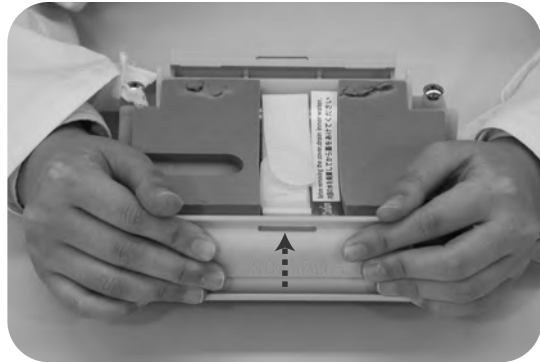
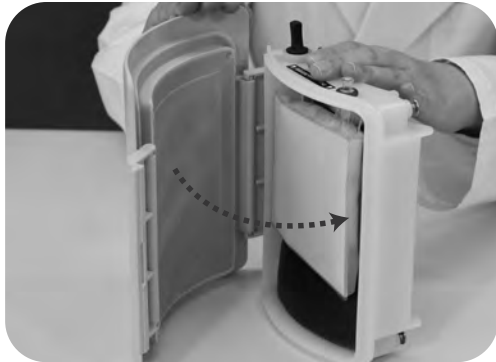

Caution

Ensure that the locks on the both sides of the thoracentesis pad are engaged securely. If they are loose, water poured into the puncture pad will leak.

Velcro tape is provided as a safeguard to prevent the thoracentesis pad from being removed accidentally while the unit is filled with water. Always ensure that the pad and the container are held together with the velcro tape.

2 Control the Volume of Pleural Effusion

The simulator allows to set the different levels of challenges by controlling volume of the effusion (capacity of the pleural space). The capacity of the pleural space is changed by the size of the lung. As factory setting, the lung is inflated and the pleural space is minimized. The space can be widened by deflating the simulated lung.

1. Insert the connector on the tip of the lung air tube into the lung air adjustment pipe located on the top of the unit. Next, screw the connector clockwise. Then remove the plug on the water inlet. (When removing the plug, hold the black handle and pull off while moving it slightly from side to side.)

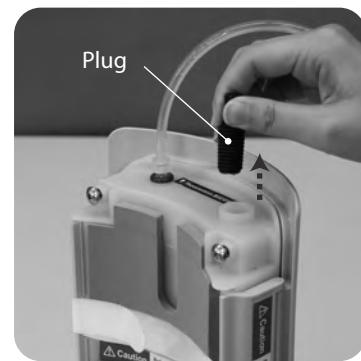

2. Connect the syringe to the three-way tap. And then turn it clockwise to lock. Open the three-way tap (set the lever to perpendicular to the syringe) and pull back the plunger of the syringe to aspirate the air from the simulated lung.



2 Control the Volume of Pleural Effusion

Approximately 150mL of air can be extracted from the simulated lung in maximum.

3. After pulling back the fully, close the three-way tap by turning the lever parallel to the syringe. Remove the syringe from the tube. Repeat the following steps when necessary to extract enough air to make pleural space that fits for the training purpose.

- Empty the syringe.
- Connect the tip of the syringe to the tube and open the three-way tap.
- Pull back the plunger and close the three way tap.
- Remove the syringe.

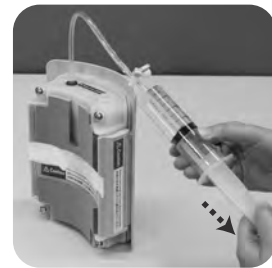
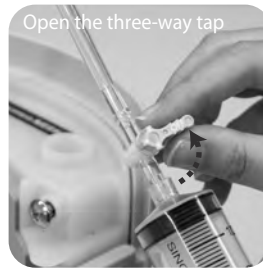

[Amount of pleural effusion (water) in the puncture unit]



When approx. 50mL of air is extracted

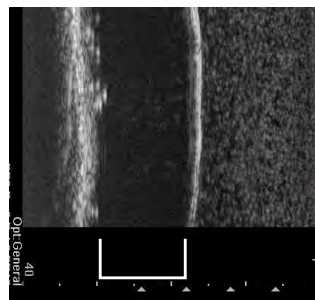

When approx. 100mL of air is extracted

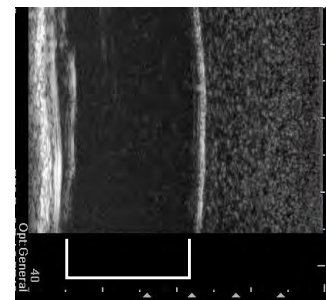

□ Pleural effusion

⚠ Caution

The ultrasonic images above show brand-new lung. In case of a used part, air might not be extracted fully. Check the ultrasound image after filling the unit with water, to see if intended volume of pleural space is made. If the simulated lung is inflated soon after extracting air from it, replace it with new one. (See p. 19 -20 for the replacement procedure.)

4. Close the cock of the three-way tap and remove the syringe from the tube.



⚠ Caution

Ensure that the cock of the three-way tap is closed before removing the syringe. If the cock is left open, air will enter into the simulated lung again.

3 Fill the Puncture Unit with Water

1. After setting the lung volume, fill the unit with water. First, insert the funnel into the water inlet after removing the plug, then pour water slowly from the plastic jar into the funnel while supporting it by hand until the water surface reaches to the reference line on the window on the back of the unit.

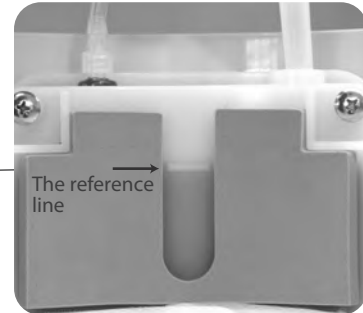
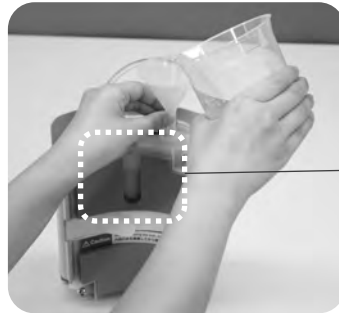

Take care not to let water in the pad exceed the reference line. When water exceeds the reference line during training due to an increase in lung capacity, discharge the excessive water.

[Water volume]

When the simulated lung is inflated fully, approximately 200mL of water can be poured into the pad. When the lung is in the most deflated condition, you can pour approximately 370 - 380mL of water.



Above mentioned water volume may differ in case of a used (punctured) simulated lung is used.

2. After filling the unit with water, insert the plug securely in the water inlet and then remove the lung air tube by turning the connector on the tip of the tube counter-clockwise.



Ensure never to close or block the opening for the lung air adjustment pipe after removing the tube. If the opening is blocked, it becomes impossible to extract the pleural effusion (water) by the syringe during thoracensis training.

1. Thoracentesis Training Preparation

Set the Puncture Unit to the Upper Torso Manikin

Wear the Puncture Unit on the Chest

4 Set the Puncture Unit to the Upper Torso Manikin

[Training with the upper torso manikin]

1. Engage the upper part of the puncture unit in the attaching slot on the manikin, and then insert and push the lower part. Be sure to use appropriate type of the puncture pad for each site. The type is indicated by the sticker on the upper part of the pad.



5 Wear the Puncture Unit on the Chest

[Training with a SP]

1. Install the fitting strap on the thoracentesis unit. Use two straps for each pad. Attach the catch of the strap by aligning the hole of the catch with the attaching screw on the top of the unit (of the shoulder strap) so that the screw head comes through the hole. Then pull the strap belt to engage the catch and the screw. (You can feel the catch snapping into place.) Attach one strap from the left side to the right side. Similarly attach another strap to the attaching screws on the lower part of the unit (for the body strap).



5 Wear the puncture Unit on the Chest

2. Wear the puncture unit from the shoulder by using the upper strap.
Put the head and an arm through the loop of the upper strap so as to let the strap hang from the shoulder to the chest on the opposite side. Adjust the length of the strap while putting the puncture unit on the targeted location (either of the left thoracic part or the right dorsal part) as required.



3. Fastening the lower strap.
Undo the buckle of the strap and then wrap it on around the body. Adjust the length of the strap as required.



Tips

To save time, adjust the length of the strap before wearing the unit. Help each other to adjust the shoulder strap.

1 Patient positioning

[Training with the upper torso manikin]

1. When conducting the training with the manikin in sitting position, place the manikin on a stable surface such as a table. In the case of training with the model in anteflexion position, use the positioning pillow.



sitting position



anteflexion position

[Training with a SP]

1. In the case of training with a SP, position the patient appropriately using a seat or chair.



⚠ Caution

- Do not mark the manikin or the pad.
- For training of the disinfection procedure of the puncture area, use water instead of disinfectant.
- Do not apply anesthesia. It might cause water leakage from the thoracentesis pad.
- A 22G or 23G hypodermic needle is recommended for puncturing.

* If you use a hypodermic needle thicker than 22G, the pad will deteriorate more rapidly.

2 Training Using the Explanation Model

1. Be Sure that the unit is empty and no water remain inside. Disassemble the puncture unit. Detach the Velcro tape of the back side and pull it off from the slits of the locks on the left and right sides.

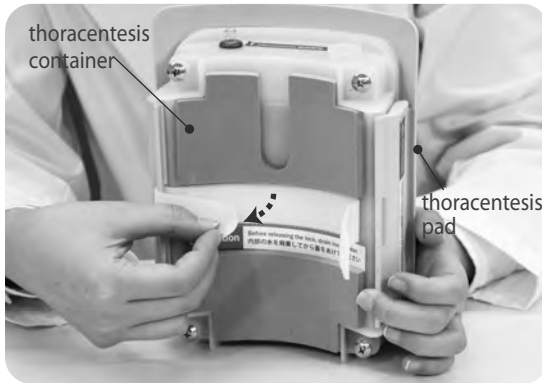

2. Next, with the pad side facing down, use the fingers of each hands to disengage the lock of the one side push it toward the front. Then, disengage the lock on the other side. After the locks are disengaged, remove the thoracentesis pad from the container.

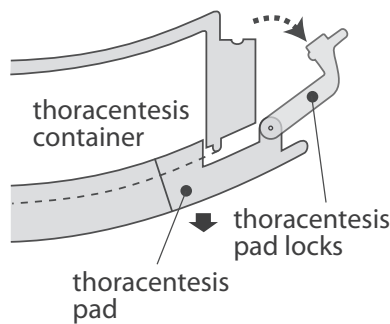
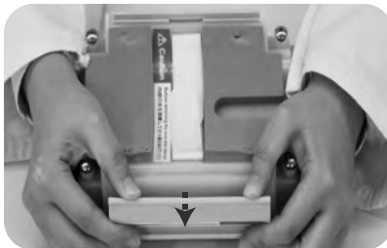

Caution

When disengaging the locks on the puncture pad, use both hands to disengage the locks one by one.

Do not try to unlock the pad with one hand (for each lock) as shown the photos below. Your skin may be pinched between the lock and the edge of the pad.

Before opening the pad, always be sure to discharge the inner water. (See p.15)



2 Training Using the Explanation Model

3. After removing the thoracentesis pad, install the explanation model.

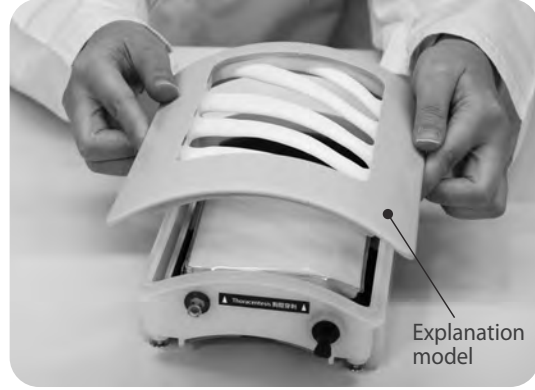

4. Engage the upper part of the thoracentesis unit with the explanation model in the attaching slot on the manikin, and then insert and push the lower part.



The explanation model facilitates three dimensional understanding of positional relationship of anatomical structures, as well as direction and depth of the needle insertion.



.....
The ribs of the explanation model represent those in the right dorsal part.



2 Change the Effusion Volume during the Session

1. First close the cock of the three-way tap of the lung air tube. Then insert the connector on the tip of the lung air tube into the lung air adjustment pipe located on the top of the unit. Next, screw the connector clockwise. Then remove the plug on the water inlet.



Close the three-way tap



Ensure that the cock of the three-way tap is closed before removing the plug of the water inlet. If the plug is removed while the cock is opened, the lung capacity might change arbitrarily.

2. When you extract the air from lung, connect the empty syringe to the three-way tap and lock it by turning clockwise. Pull the plunger while setting the three-way tap in the open position. When you air the lung, fill the syringe with air and connect it to the three way tap. Lock it by turning clockwise. Put the syringe while setting the three-way tap in the open position. After adjusting the lung size, close the cock of the three-way tap and remove the syringe from the tube.



2 Change the Effusion Volume during the Session

3. Adjust the level of water. Be sure to pour or extract the pleural effusion (water) to the reference line as instructed in p. 7.



Caution

.....
Collect the extracted water in the plastic jar or the other container to avoid spill over.

4. After the pad is filled with water to the reference line, insert the plug securely in the water inlet and remove the lung air tube, then resume training.



1. Thoracentesis Training After Training

1 After Training

[Training with the upper torso manikin]

1. Insert a finger under the lower part of the puncture pad that is installed in the manikin, then pull it to detach the puncture unit.



[Training with a SP]

1. Remove the straps from the thoracentesis unit. Hold the catch of the strap and press it toward the attaching screw until the large hole of the catch is aligned with the screw head. Then pull the catch off the unit to detach it. Detach all four catches.

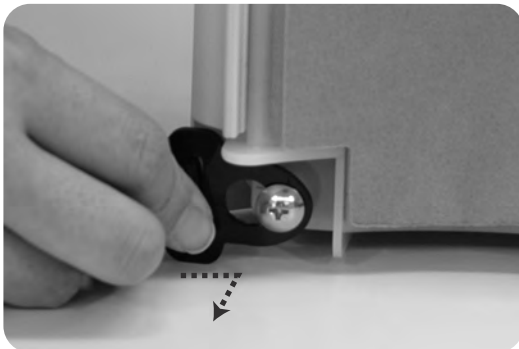

2. Remove the plug of the water inlet, and discharge the water in the pad.

After disposing the pleural effusion, use wet wipes to wipe off the jell used for ultrasonography. Be sure to avoid leaving any jell on the surface.



.....
Because the puncture part of the thoracentesis pad is made of soft and delicate material, do not apply too much pressure with a dry cloth or other material.

1. Thoracentesis Training After Training

1 After Training

3. Detach the Velcro tape of the back side and pull it out from the slit of both pad locks.

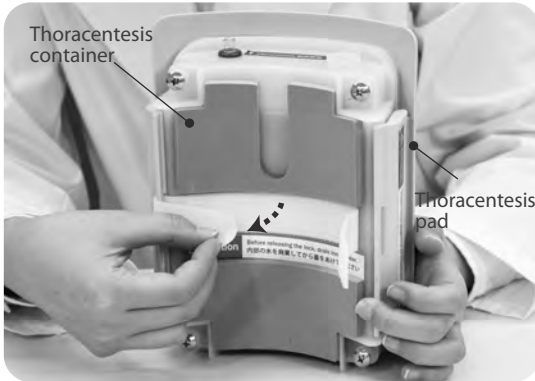

4. Disengage the thoracentesis pad and the thoracentesis container. With the pad side facing down, use the fingers of each hands to disengage the lock of the one side push it toward the front. Then disengage the lock on the other side. After the locks are disengaged, remove the thoracentesis pad from the container.

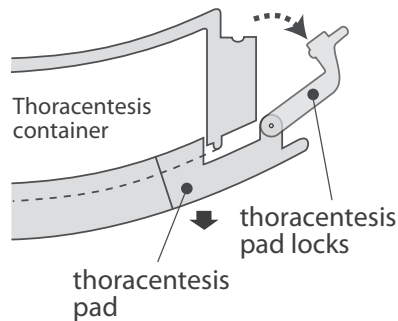
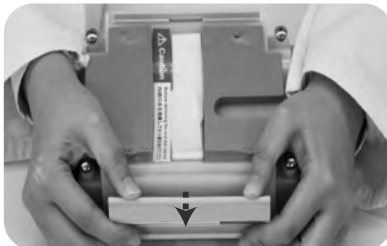

When disengaging the locks on the puncture pad, always use both hands to disengage the locks one by one.

Do not try to unlock the pad with one hand (for each lock) as shown the photos below. Your skin may be pinched between the lock and the edge of the pad.



1. Thoracentesis Training After Training

1 After Training

5. Wipe off any moisture accumulated on the thoracentesis pad and inside the thoracentesis container completely. Then, while inserting a finger under the black plate that is used to fix the simulated lung, raise the plate and the lung together. Wipe off the moisture inside.



While inserting a finger under the black plate, raise the plate from the white retainer plate.

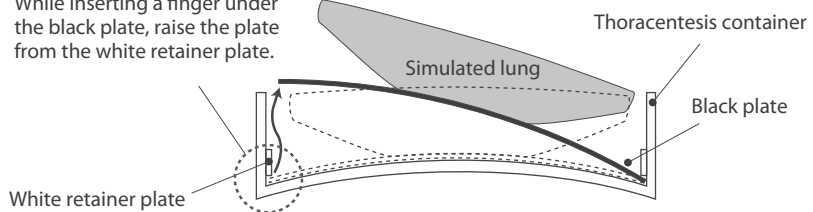

6. After the moisture is wiped off completely, reset the simulated. Insert the edge of the black plate under the white retainer plate. First, put one of the edge of the black plate under the retainer plate and then push the other side of the black plate under another retainer plate.

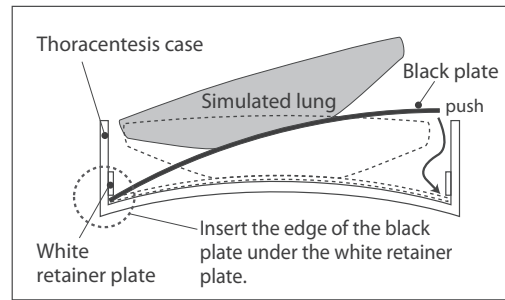

7. When the thoracentesis container is stained, clean it using mild soapy water and dry it well.

8. For storage the simulator, detach the thoracentesis pad from the thoracentesis container.

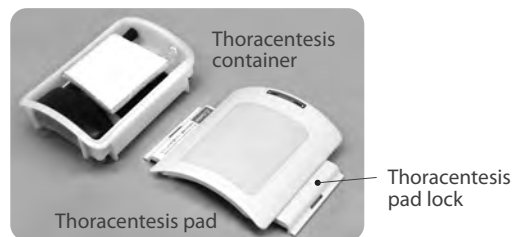

Do not store the thoracentesis unit with the pad and the container assembled and locked. This may cause deterioration of the watertight packing.

1 Removing of the thoracentesis pad

[Common to the exchange of simulated lung and the thoracentesis pad]

1. Detach the Velcro tape of the back side and pull it out from the slit of both pad locks.

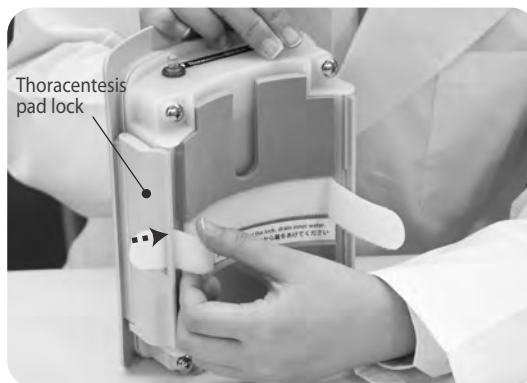
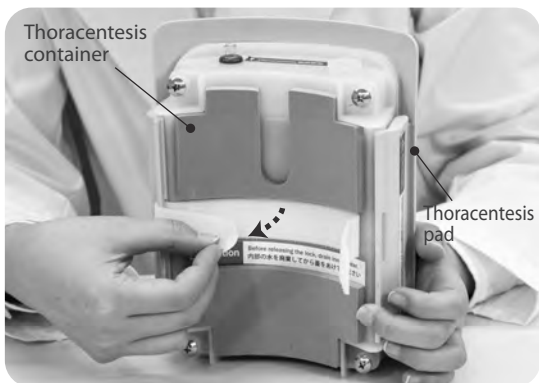

2. With the pad side facing down, use the fingers of each hands to disengage the lock of the one side push it toward the front. Then disengage the lock on the other side. After the locks are disengaged, remove the thoracentesis pad from the container.

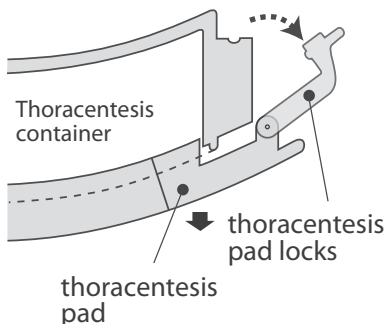
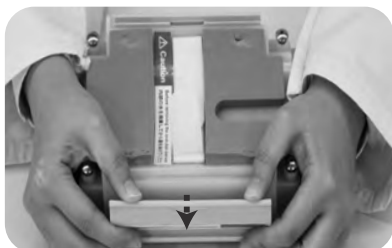

When disengaging the locks on the puncture pad, always use both hands to disengage the locks one by one.

Do not try to unlock the pad with one hand (for each lock) as shown the photos below. Your skin may be pinched between the lock and the edge of the pad.



2 Simulated lung

1. While inserting a finger under the black plate, raise the plate and the lung together. Next, hold the tube from the simulated lung that is connected to the lung air adjustment pipe located on the top of the thoracentesis container, then pull it downward to detach.

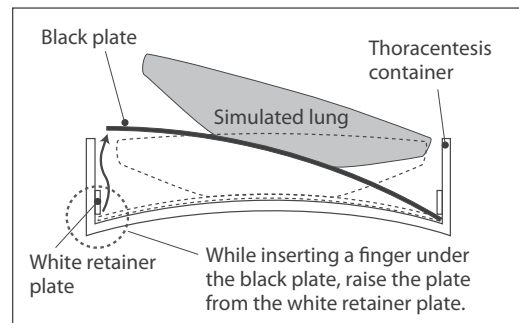

2. Replace with the new simulated lung, and then connect the tube from the lung to the lung air adjustment pipe located on the top of the thoracentesis container. Then insert the edge of the black plate under the white retainer plate. First, put one of the edges of the black plate under the retainer plate and then push the other side of the black plate under the retainer plate on the other side to install the simulated lung.

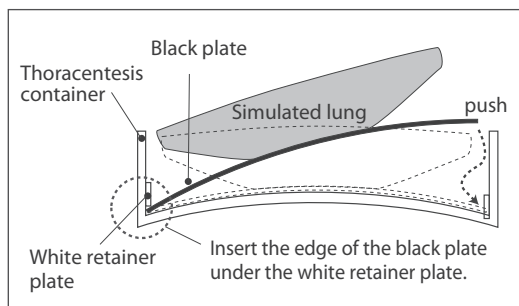

3 Assembling of the thoracentesis puncture unit

[Common to the exchange of simulated lung and the thoracentesis pad]

○ To continue training after replacing the consumable parts

1. Engage the thoracentesis pad and the thoracentesis container. With the pad (skin) side facing down, push the lock inward with both hands until you hear a "click" sound to engage it securely. After engaging the locks of both sides thread the Velcro tape through the slits on the locks .

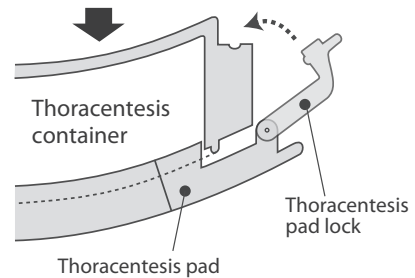
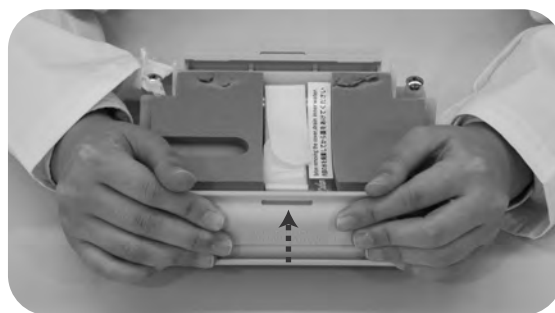

○ After training

2. For storage the simulator, detach the thoracentesis pad from the thoracentesis case.

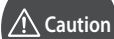

Do not store the thoracentesis unit with the pad and the container assembled and locked. This may cause deterioration of the watertight packing.

2. Pericardiocentesis Training P.21 ~ P.35



● Components for the pericardiocentesis training

(Components for MW15)

a. Upper torso manikin (including the spacer)	1	l. Connection tube (for pericardiocentesis and water drain)	1
e. Pericardiocentesis pad	1	n. Syringe (for pericardiocentesis)	1
f. Pericardiocentesis container (including simulated heart and liver)	1	p. Plastic jar (large)	1
i. Pillow	1	r. Irrigation bottle	1
k. Connection tube (for pericardiocentesis and water supply)	1	Instruction manual	

After training, detach the thoracentesis / pericardiocentesis pad from each case before storing them.

* MW 15 has two spacers instead of the thoracentesis units

1 Confirm the Setting of Simulated Heat and Liver

1. The pericardiocentesis pad and the pericardiocentesis container are packed separately.



2. The simulated heart and liver are set in the pericardiocentesis container. Turn over the container while supporting the contents with a hand to remove them from the container. Ensure that the pin on the heart is engaged in the hole on the liver and that the heart can be moved around the pin as a fulcrum. After checking, reset them into the container.

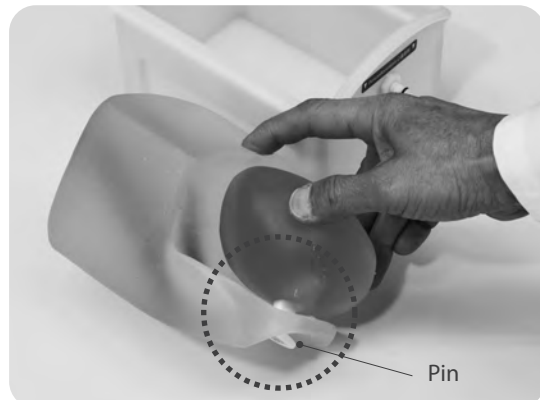
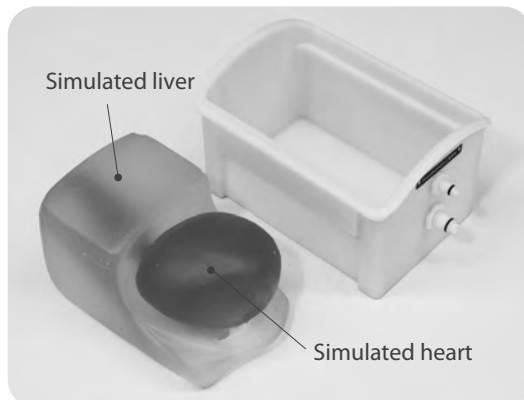

Fill the Puncture Unit with Water [1]

● Training with the Irrigation bottle

1 Assembling of the pericardiocentesis puncture unit

1. Attach the pericardiocentesis pad to the pericardiocentesis container. The upper sides are indicated by stickers. Align them in the same direction to engage them correctly, and then push the pericardiocentesis pad against the container to seal it.



2. Push the pericardiocentesis pad lock inward with both hands until you hear a "click" sound to engage it securely. Similarly engage the lock on the other side.

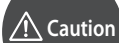
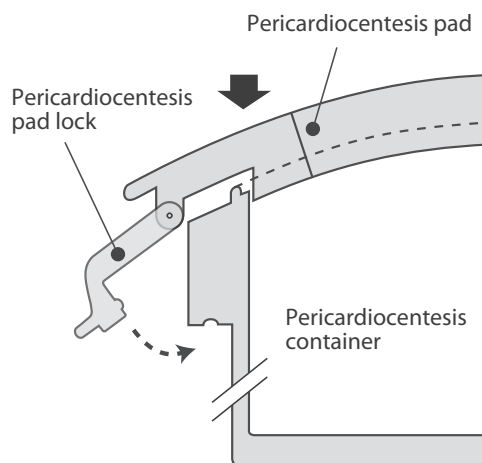

Caution

Do not force the locks as this may break the locks. Before applying additional force, ensure that the pad is correctly positioned on the container and well fitted.

2 Connect the puncture unit and water tubes

1. Put the upper torso manikin in spine position on the positioning pillow. Thread two connection tubes (a thick supply tube and a thin drainage tube) through the hole in the neck of the manikin. First thread the connector of the supply tube and then thread the drainage tube similarly.

connection tubes

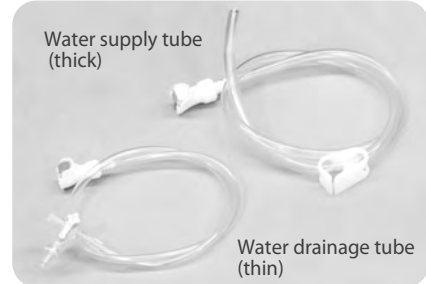

2. Insert the pericardiocentesis unit upward along the attaching slot from the lower side of the manikin to the middle of the slot. Connect the two connection tubes that are threaded through the neck hole to the connectors located on top of the pericardiocentesis unit. There are two connectors with different sizes. Connect each tube to the connector of the right size. Push the connectors until you can hear a "click" sound.

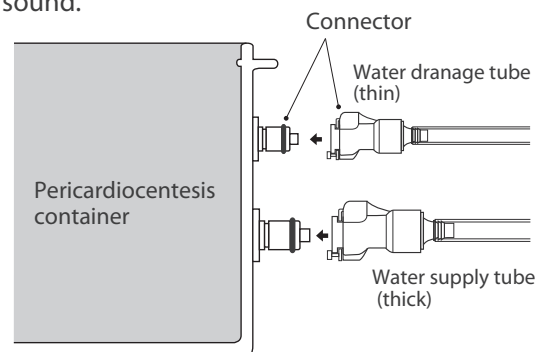

2 Connect the puncture unit and water tubes

3. After connecting the tubes to the puncture unit, push up the pericardiocentesis unit until no gap is left between the unit and the manikin.

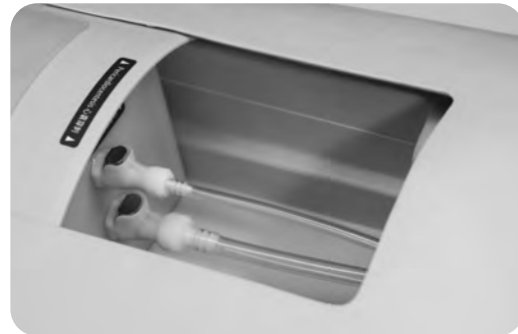

Both tubes are connected to the puncture unit.



4. Insert the spacer under the puncture unit while slightly widening the lower part of the manikin.

Spacer



.....
When inserting the spacer, align the concave part of the spacer to the convex part of the manikin.

3 Fill the puncture unit with water

1. Use the positioning pillow to set the manikin to semi-sitting position for the training.



.....
Fill water after setting the manikin in semi-sitting position to let the puncture unit be fully filled with water.

2. Connect the water supply tube (thick tube) to the irrigation bottle. Close the tube cock on the tube before fill the bottle with water.

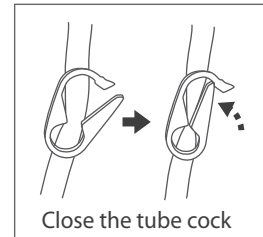

.....
Be sure to connect the tube and the bottle securely. Otherwise the tube may come off while filling water.

3. Fill the puncture unit with water

(1) Pour 500 mL of water into the irrigation bottle using the included plastic jar.

Hang the irrigation bottle on the stand. Adjust the height of the stand so that the bottom of the irrigation bottle comes at approximately 20 cm higher than the neck of the manikin. Do not raise the irrigation bottle too high because it may apply excessive water pressure to the pad.

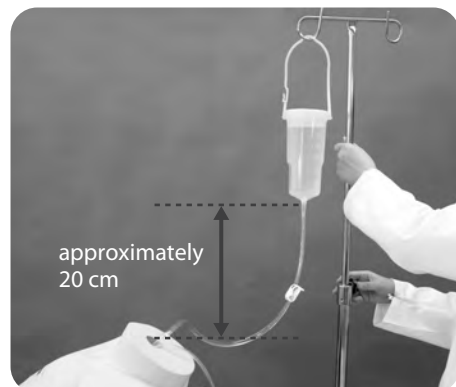

3 Fill the puncture unit with water

(2) After pouring water in the irrigation bottle, open the cock of the three-way tap on the water drainage tube, and put the end of the water tube into the plastic cup.



Open the cock

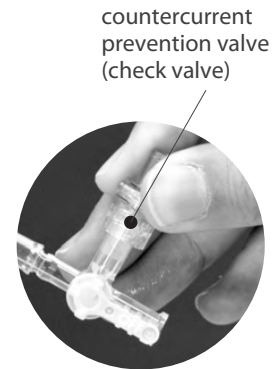

Caution

Do not remove the check valve on the three-way tap. If it is removed, it becomes impossible to aspire water while training.

(3) Open the cock on the water supply tube. The water in the irrigation bottle flows in the puncture pad. The amount of water to fill the puncture unit is 500 mL. When water comes out from the water drainage tube, close the cock on the water supply tube. Set the cock of the three-way tap on the water drainage tube into the position that is indicated in the picture below, and then remove the tube from the plastic cup. Now the simulator is ready for training.

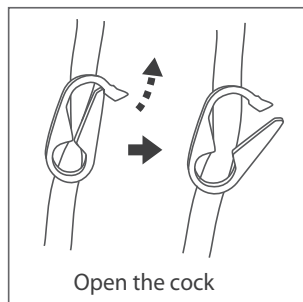

Open the cock

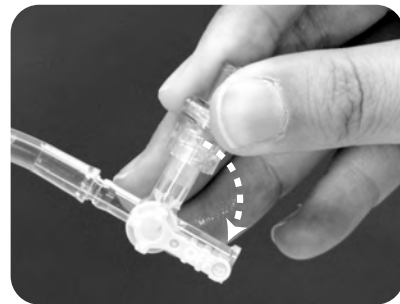

Caution

Always set the cock of the three-way tap into the position that is indicated in the upper right picture. If the cock is not in this position, it becomes impossible to aspire water while training.

When no water comes out from the water drainage tube even if the water is supplied from the irrigation bottle, lift the water supply tube so that water left in the tube flow into the pad.

When this does not work, pour a small amount of water into the irrigation bottle and open the cock on the tube again. Then conduct the procedure in step (3) after seeing water flowing out of the drainage tube.

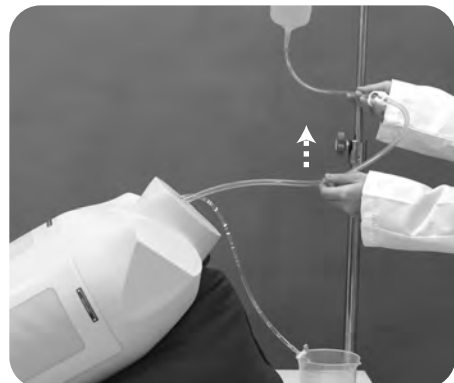

Fill the Puncture Unit with Water [2]

- Training without the Irrigation bottle

1 Fill the puncture unit with water

1. Put the pericardiocentesis container in lateral position on a flat surface, then pour approximately 500 mL of water into it. Ensure confirm that the simulated heart floats on the water.



2. Install the pericardiocentesis pad to the pericardiocentesis container.

- (1) The upper sides are indicated by stickers. Align them in the same direction to engage them correctly, and then push the pericardiocentesis pad against the container to seal it.



- (2) Push the pericardiocentesis pad lock inward with both hands until you hear a "click" sound to engage it securely. Similarly engage the lock on the other side.

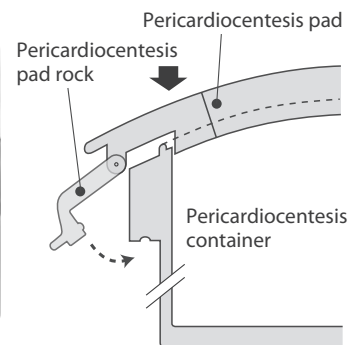

Caution

.....
Be careful not to spill water when setting the locks.

2 Connect the puncture unit and tubes

- Put the upper torso manikin in spine position on the attached positioning pillow. Thread two connection tubes (a thick supply tube and a thin drainage tube) through the hole in the neck of the manikin. First thread the connector of the supply tube and then thread the drainage tube similarly. Then close the tube cock on the water injection tube and the cock of the three-way tap on the water drainage tube.

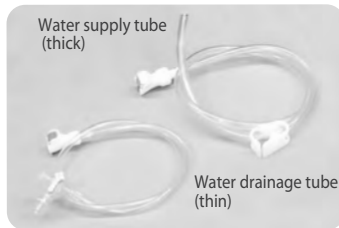

Close the tube cock on the water supply tube



Close the cock of the three-way tap on the water drainage tube



- Insert the pericardiocentesis unit upward along the attaching slot from the lower side of the manikin to the middle of the slot. Connect the two tubes that are threaded through the neck hole to the connector located on top of the pericardiocentesis pad. There are two connectors with different sizes. Connect each tube to the connector of the right size. Push the connectors until you can hear a "click" sound.

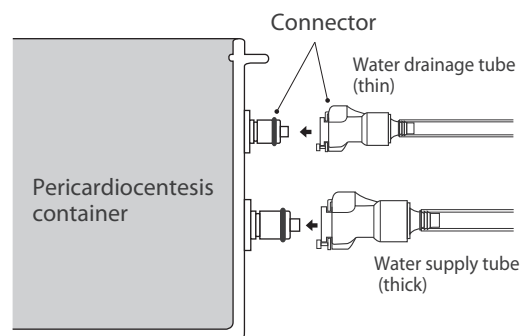

2 Connect the puncture unit and tubes

3. After connecting the tubes to the puncture unit, push up unit until no gap is left between the unit and the manikin.



The state that connected two tubes with the puncture unit



4. Insert the spacer under the puncture unit while slightly widening the lower part of the manikin.

Spacer



When inserting the spacer, align the concave part of the spacer to the convex part of the manikin.

3 Fill the puncture unit with water

1. Use the positioning pillow to set the model to semi-sitting position for the training.



2. Connect the syringe filled with approximately 50 mL of water to the water supply tube. Open the cock of the three-way tap on the water drainage tube and put the end of the tube into the plastic cup.

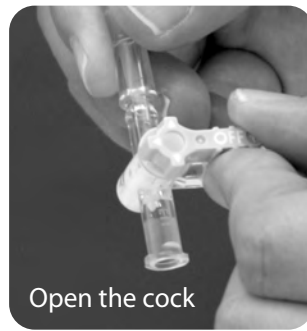

2. Open the tube cock on the water supply tube and inject the water of the syringe into the puncture unit. Inject water until water comes from the water drainage tube. Then close the tube cock on the water supply tube and remove the syringe. And then set the cock of the three-way tap on the water drainage tube into the position that is indicated in the picture below, and then remove the tube from the plastic cup. Now the simulator is ready for training.



Open the tube cock



Caution

.....
In case no water flow out after injecting 50mL of water, refill the syringe and inject additional water into the puncture unit. Always be sure to close the cock on the water supply tube before removing the syringe. Otherwise, water in the unit will be drained due to atmospheric pressure.

2. Pericardiocentesis Training Training

1 Training

1. Set the model in semi-sitting position set using the positioning pillow to conduct the training.



Caution

- Do not mark the manikin or the pad.
- For training the disinfection procedure of the puncture part, use water instead of disinfectant.
- Do not apply anesthesia. It might cause water leakage from the pericardiocentesis pad.
- A 18G blood vessel custody needle is recommended for puncturing.
 - * If you use a blood vessel custody needle thicker than 18G, the pad will deteriorate more rapidly.

2. Pericardiocentesis Training After Training

1 After Training

1. After training dispose the remaining water from the irrigation bottle. Remove the water supply tube from the irrigation bottle. Remove the positioning pillow and put the manikin in supine position on the table. Prepare a container such as a bucket for discharged water. Put the end of two tubes in the container so that the tube tips come lower than the manikin.



2. Open the tube cock on the water supply tube. Then, lift the tip of the water drainage tube and open the three-way tap. Water flows out through the water supply tube. When the outflow of the water stops, tilt the manikin by lifting its bottom side to empty the remaining water in the unit.

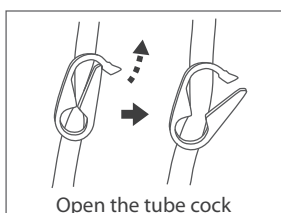
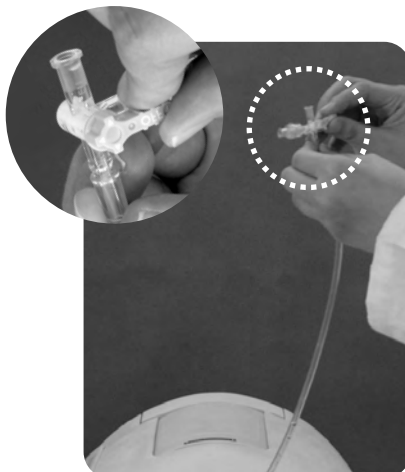

2. Pericardiocentesis Training After Training

1 After Training

After discharging the water in the puncture unit, remove the unit from the upper torso manikin.

- (1) Insert a finger into the gap between the manikin and the spacer, then pull the spacer upward while widening the opening. Slide the pericardiocentesis unit caudally to create a gap between the unit and the manikin. Put a hand into the gap and slide the unit down.



- (2) Remove the two tubes connected to the puncture unit. Press the metal plate on the connector to unlock the tube. Pull out two tubes from the hole on the neck one by one. After removing the tubes, slide the puncture pad further to remove it from the manikin.



Press the metal plate to unlock. Pull off the tube with the connector.

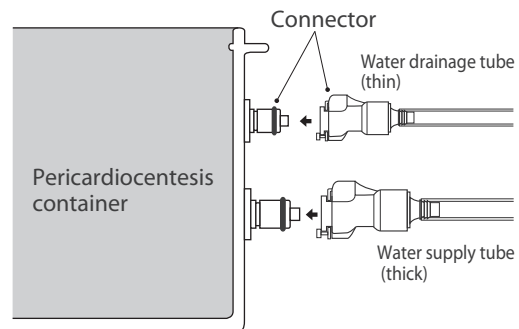

2. Pericardiocentesis Training After Training

1 After Training

4. Place the removed puncture unit on a flat surface, pull up the lock of the pericardiocentesis pad using both hands and disengage the lock one by one. Similarly disengage the lock on the other side. After disengaging the two locks, remove the pericardiocentesis pad from the pericardiocentesis container and then discharge the water left in the case.

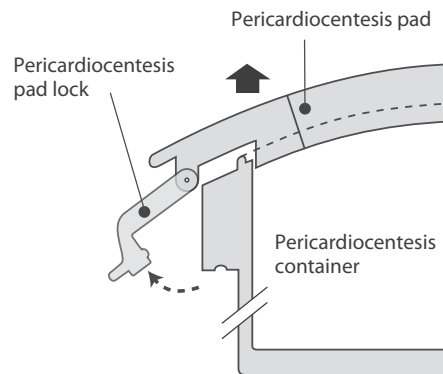
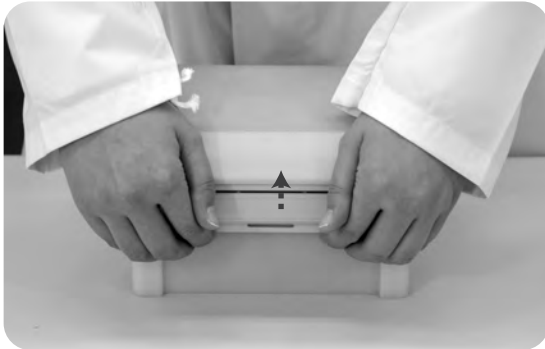

.....
The locks are engaged securely to prevent water leakage. For your safety, disengage the locks one by one using both hands.

5. Wipe off the moisture left on the pericardiocentesis pad and in the pericardiocentesis container.



2. Pericardiocentesis Training After Training

1 After Training

6. Turn over the container while supporting the contents to remove them from the container. Wipe off the moisture left on the simulated heart and liver and dry them well. After they are dried, reset the heart and liver. When the positioning pillow becomes wet, dry it naturally before storage.

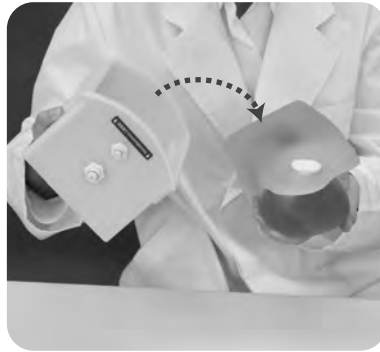
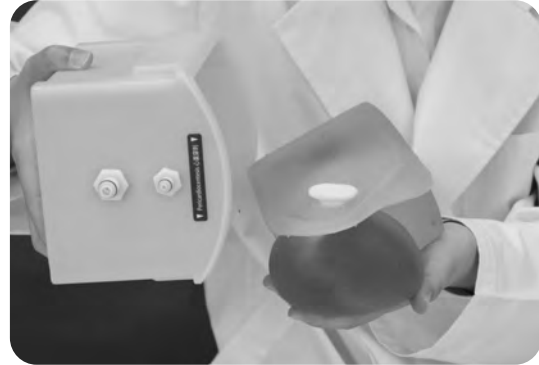

7. For storage, detach the pericardiocentesis pad from the pericardiocentesis container.



Do not store the thoracentesis unit with the pad and the container assembled and locked. This may cause deterioration of the watertight packing.



When the pericardiocentesis pad worn out by use, replace it with new one to conduct the training.





Caution

Don't mark on the model and other components with pen or leave printed materials contacted on their surface.
Ink marks on the models will be irremovable.

- For inquiries and service, please contact your distributor or KYOTO KAGAKU CO., LTD.

KYOTO KAGAKU co.,LTD

URL•<http://www.kyotokagaku.com> e-mail•rw-kyoto@kyotokagaku.co.jp

■ Main Office and Factory

15 Kitanechoya-cho Fushimi-ku Kyoto 612-8388, Japan
Telephone : 81-75-605-2510
Facsimile : 81-75-605-2519

■ LA Office (for USA , CANADA and Mexico customers)

3109 Lomita Boulevard, Torrance, CA 90505 ,USA
Telephone : 1-310-325-8860
Facsimile : 1-310-325-8867

The contents of the instruction manual are subject to change without prior notice.

No part of this instruction manual may be reproduced or transmitted in any form without permission from the manufacturer.

Please contact manufacturer for extra copies of this manual which may contain important updates and revisions.

Please contact manufacturer with any discrepancies in this manual or product feedback. Your cooperation is greatly appreciated.